



# LILLNORD

next generation cooling technologies



**RESERVEDELSPRISLISTE**

**SPARE PARTS PRICE LIST**

**ERSATZTEILPREISLISTE**

**PG 100**

Gyldig fra/Valid from/Gültig ab

**01.08.2024**

Indhold / Content / Inhalt

3	PG 100
4	Betjeningskasse / Control box / Bedienungsbox
4	Blæser / Fan / Gebläse
4	El-kasse / Electricial box / Elektroschaltkasten
5	Vand / Water / Wasser
5	Damp / Steam / Dampf
5	Komplet dampgenerator / Complete steam generator / Kompletter Dampfgenerator
6	Dampgenerator / Steam generator / Dampfgenerator
6	Komplet top m/elektrode / Complete lid w/electrodes / Kompletter Deckel m/Elektroden
7	Klap / Flap / Klappe
7	Ekstraudstyr / Optional extras / Sonderausstattung
7	PG 101 / 102 / 103 / 104



## PG 100

		DK	GB	D	In €
A	060 776	Hygroskop, manuel, special for brødsyre	Hygroskop, manual, special for dough acid	Hygroskop, manuell, speziell für Brotsäure	466,58
A	066 036	Kabel for hygroskop	Cable for hygroskop	Kabel für Hygroskop	148,07
B	060 880	Hygroskopknap	Button for hygroskop	Hygroskopknopf	22,51
B	060 881	Aksel til knap Hygroskop	Shaft for button Hygroskop	Shaft für Hygroskopknopf	16,76
C	s. 4	Betjeningskasse	Control box	Bedienungsbox	
D	s. 4	Blæser	Fan	Gebläse	
D	4101 0006	Topplade med gitter for betjening	Top with lattice for control	Top mit Gitter für Bedienung	104,64
D	4101 0005	Topplade med gitter uden betjening	Top with lattice without control	Top mit Gitter ohne Bedienung	104,64
E	4105 1132	Varmelegeme	Heating element	Heizkörper	106,51
F	s. 4	El-kasse	Electricitybox	El-kasten	
G	s. 5	Vand	Water	Wasser	
H	s. 5	Damp	Steam	Dampf	
I	s. 7	Klap	Flap	Klappe	
J	011 761	Skrue t/ afdækning	Screw f/ cover	Schrauben f/ Abdeckung	0,63
	4105 1141	Installationskit til føler	Installation kit for sensor	Zubehörbeutel für Sensor	107,83
	4105 1050	Afdækn. f. aut. tømmev.	Cover for aut. drain valve	Abd. f. aut. Entl.ventil	15,79

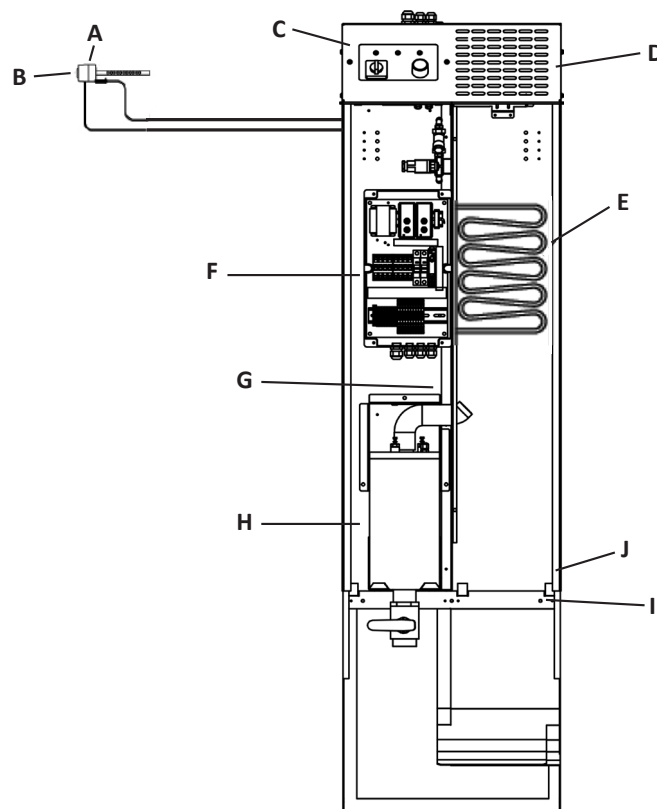

## Betjeningskasse Control box Bedienungsbox

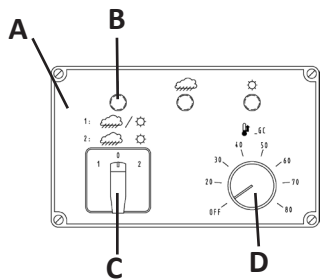

		DK	GB	D	In €
A	4105 1112	Kompl. betjeningsbox	Control box, compl.	Bedienbox, kompl.	381,39
B	060 501	Lampe komplet	Lamp complete	Lampe komplett	16,75
B	060 505/506	Fatning/linse, grøn Ikke længere til rådighed	Socket/lens, green No longer available	Socket/Linse, grün Nicht länger verfügbar	N.A
B	060 508	Pære 24V, 20mA	Bulb 24V, 20mA	Birne 24V, 20mA	8,99
C	060 945	Omskifter 1-0-2	Switch 1-0-2	Schalter 1-0-2	67,76
D	060 728	Termostat	Thermostat	Thermostat	138,16
D	060 117	Termostatknop	Thermostat, button	Thermostatknopf	7,69
D	060 161	Dæksel, grøn	Lid, green	Knopfdeck, grün	1,96
D	060 171	Pil, grøn	Arrow, green	Pfeil, grün	1,13
	4105 1120	Kabel betjeningsbox	Cable control box	Kabel Bedienbox	46,49
	062 558	Betjeningsbox, tom	Control box, empty	Bedienbox, leer	54,49

## Blæser Fan Gebläse

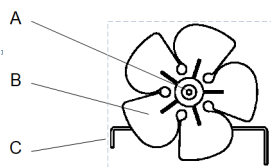

		DK	GB	D	In €
A	4101 0076	Blæsemotor, komplet	Fan motor, complete	Gebläsemotor, komplett	79,64
B	015 212	Vinge	Fan blade	Gebläseflügel	9,08
C	4105 1027	Ophæng til ventilator	Suspension for fan	Aufhängung für Gebläse	28,69

## Elkasse Electrical box Elektroschaltkasten

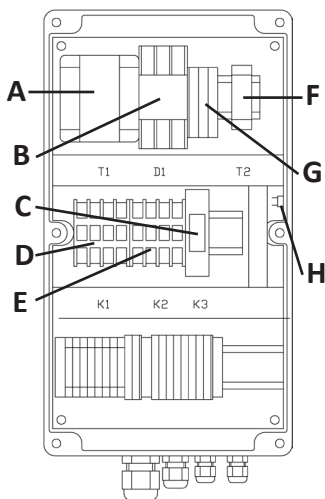

**K= Komplet  
Complete  
Komplett**

		DK	GB	D	In €
A	061 842	Trafo 230/24V - T1	Transformer 230/24V - T1	Trafo 230/24V - T1	73,33
B	061 311	Relæ spec. 959 - D1	Relay spec. 959 - D1	Relais spec. 959 - D1	297,57
B	061 618	Sokkel til relæ 959	Socket for relay 959	Socket für relais 959	17,28
C	061 531	Relæ 2-polet, 24VAC, G2R-2SN, 3x230V	Relay 2-polar, 24VAC, G2R-2SN, 3x230V	Relais 2-polig, 24VAC, G2R-2SN, 3x230V	43,23
C	061 532	Sokkel til 061 531	Socket for 061 531	Socket für 061 531	13,65
D	061 711	Kontaktor (4s) 24 VAC varme - K1	Contacteur (4s) 24VAC heat - K1	Schütz (4s) 24 VAC Wärme - K1	28,97
E	061 710	Kontaktor (3s+1b) 24VAC fugt - K2	Contacteur (3s+1b) 24VAC humidity - K2	Schütz (3s+1b) 24 VAC Feuchtigkeit - K2	25,87
F	061 058	Måletransformer - T2	Current transformer - T2	Messumwandler - T2	109,47
G	062 037	Sikring 3,15A	Fuse 3,15A	Sicherung 3,15A	1,00
G	062 038	Sikring 6,3A	Fuse 6,3A	Sicherung 6,3A	1,65
G	062 034	Sikringsholder	Fuse holder	Sicherungshalter	16,163
H	061 081	Føler -bimetal	Superheating sensor	Überhitzungssicherung	49,32
	4105-1121	Tom el-boks m/ forskruninger	Empty el-box with bushings	Leerer Elektroschaltkas- ten mit Verschraubung	195,77
K	4105-1111	El-styring 380/220V	Electr. control 380/220V	Elektr. steuerung 380/220V	1233,73
		Flere på forespørgsel	More on demand	Mehrere auf Anfrage	
	062 564	Løst låg	Empty lid	Leerer Deckel	108,45



**LILLNORD**

next generation cooling technologies

Vand

Water

Wasser

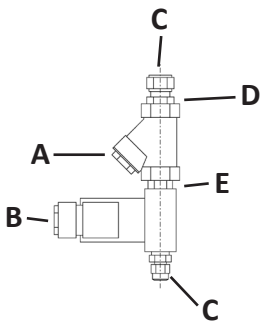

		DK	GB	D	In €
A	013 055	Filter 3/8"	Filter 3/8"	Filter 3/8"	25,15
B	013 121	Magnetventil	Solenoid valve	Magnetventil	94,45
	013 126	Stik til magnetventil	Plug for sol. valve	Stecker f. Magnetventil	10,56
C	013 076	Slangeforskruing	Hose union	Schlauchnippel	6,28
D	013 074	Nippelmuffe	Bushing	Reduzierung	4,53
E	013 071	Brystnippel	Hexagon nippel	Brustnippel	4,89
	41051134	Komplet magnetventil med filter	Solenoid valve, complete with filter	Komplett Magnetventil mit Filter	178,67

Damp

Steam

Dampf

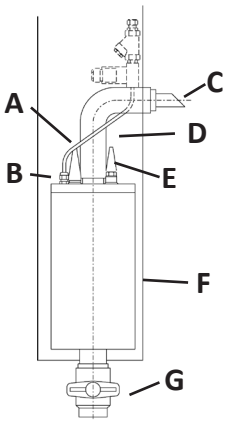

		DK	GB	D	In €
A	014 315	Vandslange 6/4,5	Water hose 6/4,5	Wasserschlauch 6/4,5	4,19/m
B	062 834	PG 7, forskruing	PG 7, bushing for water filling	PG 7, Verschraubung für Wasserzufuhr	5,62
C	4105 1039	Dampdyse t/ dampslange	Steam nozzle f/steamhose	Dampfdüse f/Dampfschlauch	62,05
D	014 305	Dampslange 40x90	Steam hose 40x90	Dampfschlauch 40x90	44,71
E	064 431	Gummitylle til elektrode	Rubber nipple for electrode	Gummitülle für Elektroden	5,56
F		Dampgenerator	Steam generator	Dampfgenerator	
G	011 252	Tømmeventil manuel	Drain valve manual	Entleerungsventil manuell	112,45

Komplet dampgenerator

Complete steam generator

Kompletter Dampfgenerator

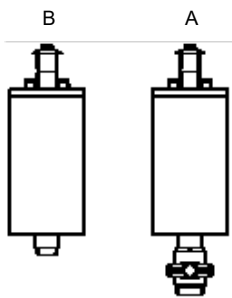

		DK	GB	D	In €
A		Komplet, med ventil	Complete, with valve	Komplett, mit Ventil	
	4005 1069	m/ Elektrode E200/30	w/ Electrode E200/30	m/ Elektrode E200/30	1056,07
	4005 1070	m/ Elektrode E200/20	w/ Electrode E200/20	m/ Elektrode E200/20	1056,07
	4005 1071	m/ Elektrode E200/10	w/ Electrode E200/10	m/ Elektrode E200/10	1056,07
	4005 1072	m/ Elektrode E200/5	w/ Electrode E200/5	m/ Elektrode E200/5	1056,07
	4005 1073	m/ Elektrode E200/Ø25	w/ Electrode E200/Ø25	m/ Elektrode E200/Ø25	891,26
B		Komplet, uden ventil	Complete, without valve	Komplett, ohne ventil	
	4005 1064	m/ Elektrode E200/30	w/ Electrode E200/30	m/ Elektrode E200/30	944,33
	4005 1065	m/ Elektrode E200/20	w/ Electrode E200/20	m/ Elektrode E200/20	944,33
	4005 1066	m/ Elektrode E200/10	w/ Electrode E200/10	m/ Elektrode E200/10	944,33
	4005 1067	m/ Elektrode E200/5	w/ Electrode E200/5	m/ Elektrode E200/5	944,33
	4005 1068	m/ Elektrode E200/Ø25	w/ Electrode E200/Ø25	m/ Elektrode E200/Ø25	779,50



**LILLNORD**

next generation cooling technologies

Damp-  
generator

Complete steam  
generator

Kompletter  
Dampfgenerator

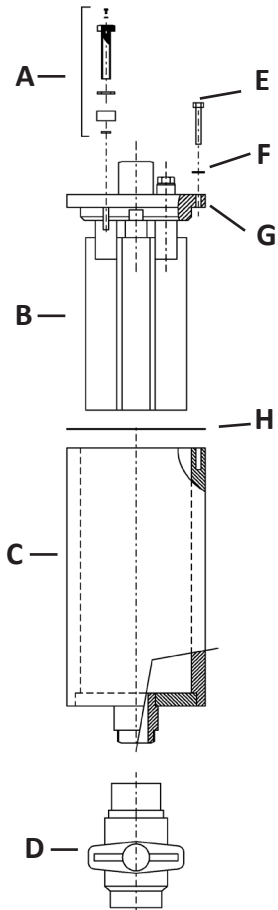

		DK	GB	D	In €
A	4005 1004	Komplet elektrode-bolt M10	Complete electrode bolt M10	Kompletter Elektrode Bolz M10	18,92
A	011 702	Sætskrue 4x8 A2	Screw 4x8 A2	Maschinschraube 4x8 A2	1,17
A	011 727	Tandskive 4mm A2	Washer 4mm A2	Zahnschreibe 4mm A2	0,20
A	016 104	Elektrodebolt 10x55	Electrode screw 10x55	Elektrodenschraube 10x55	2,73
A	011 732	Tandskive 10mm A2	Washer 10mm A2	Zahnschreibe 10mm A2	0,73
A	4005 1021	Elektrodebøsning PP t/M10	Electrode bushing PP f/M10	Elektrodebuchse PP f/ M10	3,50
A	011 190	O-ring EPDM 70 - 9,3 x 2,4	O-Packing EPDM 70 - 9,3 x 2,4	O-Ring EPDM 70 - 9,3 x 2,4	3,07
B	4005 1052	Elektrode E200/30 mm, antimagnetisk nikkel	Electrode E200/30 mm, anti-magnetic nickel	Elektrode E200/30 mm, antimagnetischer Nickel	131,62
B	4005 1053	Elektrode E200/20 mm, antimagnetisk nikkel	Electrode E200/20mm, anti-magnetic nickel	Elektrode E200/20 mm, antimagnetischer Nickel	131,62
B	4005 1054	Elektrode E200/10 mm, antimagnetisk nikkel	Electrode E200/10 mm, anti-magnetic nickel	Elektrode E200/10 mm, antimagnetischer Nickel	131,62
B	4005 1060	Elektrode E200/5 mm, antimagnetisk nikkel	Electrode E200/5 mm, anti-magnetic nickel	Elektrode E200/5 mm, antimagnetischer Nickel	131,62
B	4005 1055	Elektrode, rund Ø25 mm	Electrode, round Ø25 mm	Elektrode, rund Ø25 mm	119,72
C	4005 1074	Beholder PG 100	Container PG 100	Behälter PG 100	222,12
D	011 252	Tømmeventil man. 1 1/4"	Drain valve man. 1 1/4"	Entleerungsventil man. 1 1/4"	112,45
E	011 825	Fransk skrue	Coach screw	6kt-Holzschraube	0,64
F	011 736	Spændeskive 6,4 mm	Washer 6,4 mm	Facettenscheibe 6,4 mm	0,44
G	4005 1005	Låg A40	Lid A40	Deckel A40	185,81
H	013 094	Gummipakning 160 mm t/ PG-beholder	Rubber packing 160 mm f/ PG container	Deckeldichtung 160 mm f/ PG-Behälter	8,56
	4005 1091	Afstandsstykke t/ 5 mm Elektrode	Plastic washer f/ 5 mm electrode	Abstandshalter f/ 5 mm Elektrode	6,57

Komplet top  
m/elektroder

Complete lid  
w/ electrodes

Kompletter Deckel  
m/ Elektroden

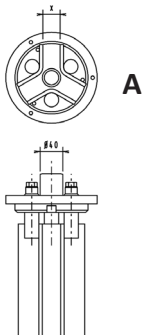

		DK	GB	D	In €
A	4005 1059	m/ Elektrode E200/30	w/ Electrode E200/30	m/ Elektroden E200/30	677,56
A	4005 1058	m/ Elektrode E200/20	w/ Electrode E200/20	m/ Elektroden E200/20	677,56
A	4005 1057	m/ Elektrode E200/10	w/ Electrode E200/10	m/ Elektroden E200/10	677,56
A	4005 1061	m/ Elektrode E200/5	w/ Electrode E200/5	m/ Elektroden E200/5	677,56
A	4005 1056	m/ Elektrode E200/Ø25	w/ Electrode E200/Ø25	m/ Elektroden E200/Ø25	507,10

**BEMÆRK:**

Ved udskiftning af elektroder anbefaler vi samtidig udskiftning af kontaktor K2, nr. 061710.

**PLEASE NOTE:**

When exchanging the electrodes we recommend simultaneous exchange of Contactor, K2 no. 061710

**BITTE NOTIEREN:**

Beim Austausch der Elektroden empfehlen wir gleichzeitigen Austausch von Schütz, K2, Nr. 061710



**LILLNORD**

next generation cooling technologies

Klap

Flap

Klappe

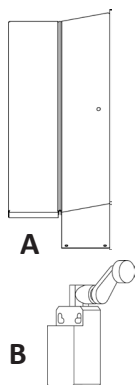

		DK	GB	D	In €
A	4105 1133	Klap m/ konsol	Flap w/ bracket	Klappe m/ Konsole	143,88
	012 574	Kugle snaplås	Ball catch	Kugelschappschloss	20,69
B	061 195	Switch t/ klap	Switch f/ flap	Klappenschalter/Endschalter	53,35
	012 535	Klaverhængsel 15 cm	Hinge 15 cm	Klavierscharnier 15 cm	50,28

### Ekstraudstyr Optional extras Sonderausstattung

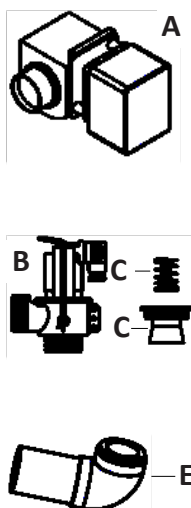

		DK	GB	D	In €
A	013 100	Motorventil 24 VAC	Motor valve 24 VAC	Motorventil 24 VAC	269,64
B	013 092	Tømmeventil aut. 1 1/4"	Drain valve aut. 1 1/4"	Entleerungsventil aut. 1 1/4"	438,68
C	013 088	Fjeder til tømmeventil	Spring for drain valve	Feder für Entleerungsventil	28,63
D	013 089	Gummimembran	Rubber diaphragm	Gummimembran	105,46
E	4005 1081	Bøjning til tømmeventil	Bending for drain valve	Biegung für Entleerungsventil	172,64
	4105 1050	Afdækning for 013092	Cover for 013092	Abdeckung für 013092	15,79
	061 317	Relæ 966	Relay 966	Relais 966	129,93
	061 618	Sokkel til relæ 061317	Socket for relay 061317	Socket für Relais 061317	17,28
	4105 1033	Stødbande	Bumper rail	Rammschutz	94,99

### PG 101 / 102 / 103 /104

		DK	GB	D	In €
	4105 1135	El-styrebox	Junction box	Verbindungsbox	769,72
	061 518	Relæ RA	Relay RA	Relais RA	30,70

Lillnord A/S  
Knudsminde 2  
DK-8300 Odder

Tel. +45 8780 3130  
Fax: +45 8780 3131  
Email: [info@lillnord.dk](mailto:info@lillnord.dk)



**LILLNORD**  
next generation cooling technologies